

## CEILINGS

WALK-ABOUT™ >

**RONDO®**

# RONDO WALK-ABOUT™ TRAFFICABLE CEILING SYSTEM

## SUMMARY

The Rondo WALK-ABOUT™ System provides a framework onto which a trafficable platform can be installed in the plenum area above ceilings for servicing mechanical and electrical services. Using standard Rondo steel stud profiles with purpose made joiners and clips, the WALK-ABOUT system is suspended from the structure above to provide a safe and secure access to services whilst simultaneously providing a support for the ceiling beneath.

## SUITABLE FOR:

- Steel Ceiling Grid Systems
- Supporting a Walking Platform in the Ceiling Plenum
- Seismic Designs\*
- Supporting of direct fixed or fully suspended ceilings beneath

## SPECIAL FEATURES

- Seamlessly integrates with Rondo KEY-LOCK® and Rondo DUO® Ceiling Systems
- Basic system design will accept a 1.1kN point load with a deflection limit of L/360

## IN PRACTICE

As the second largest air conditioned footprint on earth (after NASA), the *Venetian Resort and Casino, Macau* is possibly one of the finest examples of the Rondo WALK-ABOUT system in situ, utilizing over 30,000m<sup>2</sup> of WALK-ABOUT ceiling to access their extensive services above ceiling level. The system also acted as a structure to support the curved KEY-LOCK® ceiling, forming the famous "sky" ceiling of the resort.

\* Seismic activity varies significantly in the markets where the Rondo WALK-ABOUT System may be installed and therefore Rondo's Technical Services Department should be contacted for assistance.

## IMPORTANT NOTE:

Rondo recommends its products and systems are installed by a qualified tradesperson and according to the relevant codes and standards outlined on page 256 of this manual.

## CONTENTS:

COMPONENTS 64

TYPICAL APPLICATION DETAILS 65

INSTALLATION DETAILS 66

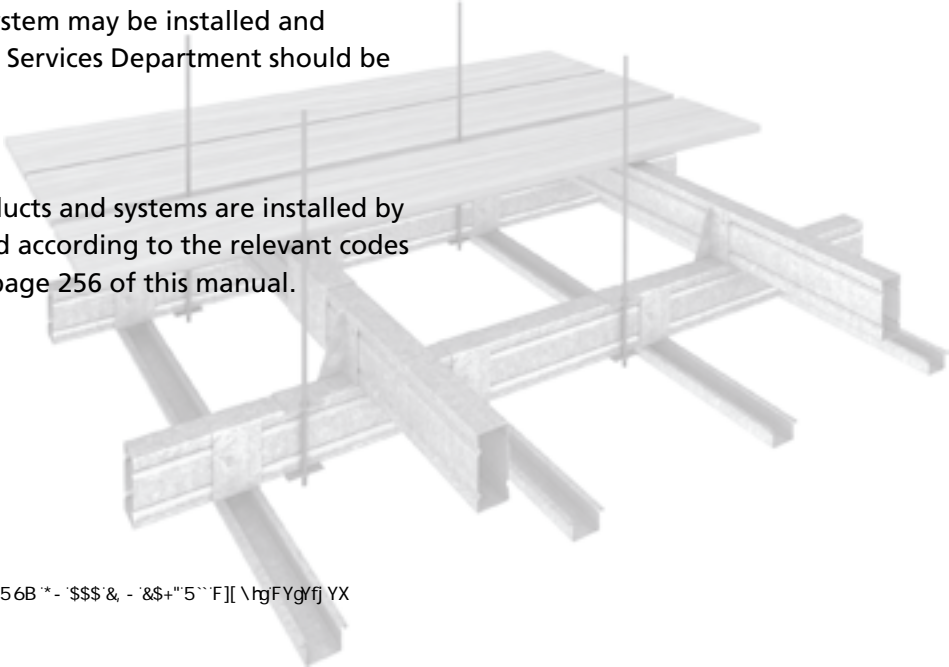

# RONDO WALK-ABOUT™ COMPONENTS

**PRIMARY SECTIONS**

112	64mm x 0.50bmt Stud
-----	---------------------

**FURRING CHANNELS**

129	28mm Furring Channel
308	16mm Furring Channel

**WALL TRIM**

111	64mm x 28mm x 0.50bmt with hem
-----	--------------------------------

**SECTION JOINERS**

224	Stud to Furring Channel Joiner
270	90° Stud to Stud Joiner

**SUSPENSION ROD & BRACKET**

271	Bracket to suit 8mm rod
Not Supplied	8mm Threaded rod

**PRIMARY SECTION**



112

**FURRING CHANNELS**

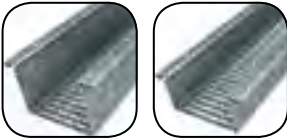

129

308

**WALL TRIM**

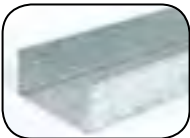

111

**SECTION JOINERS**

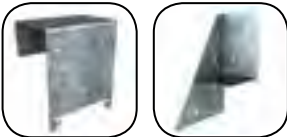

224

270

**SUSPENSION ROD & BRACKET**



271

THREADED ROD

## TYPICAL APPLICATION DETAILS

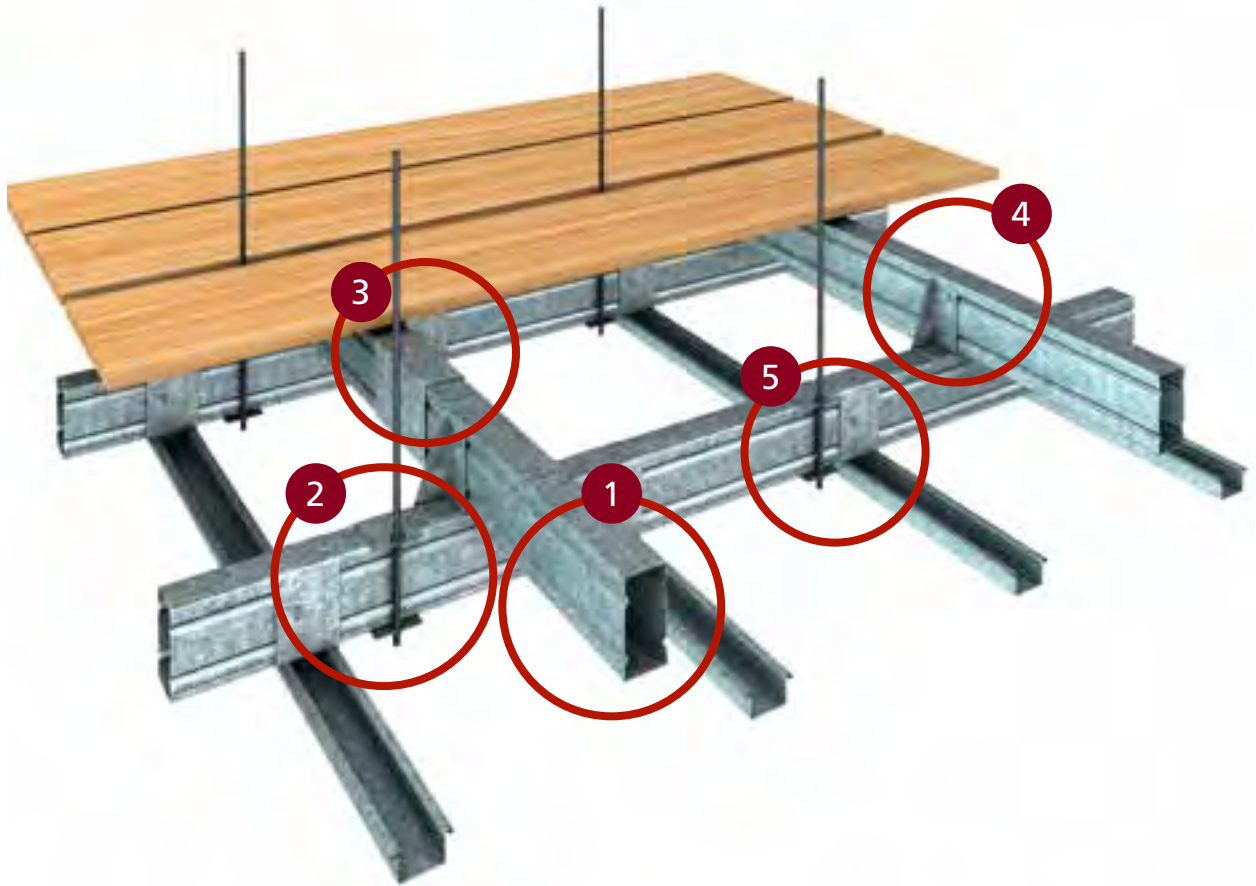

*Circled areas on the drawing refer to figures shown in more detail on the following pages.*

Once the framework is constructed, a walking platform can be installed in accordance with AS 1657-1992, the current *“Design, Construction and Installation Code”* for *“Fixed Platforms, Walkways, Stairs and Ladders”*.

Although Rondo does not manufacture or supply systems or components for the construction of walking platforms, our Technical Services Department can assist customers in determining their requirements.

# INSTALLATION DETAILS



■ BOXED STUDS



■ ATTACHING STUDS TO THE ROD

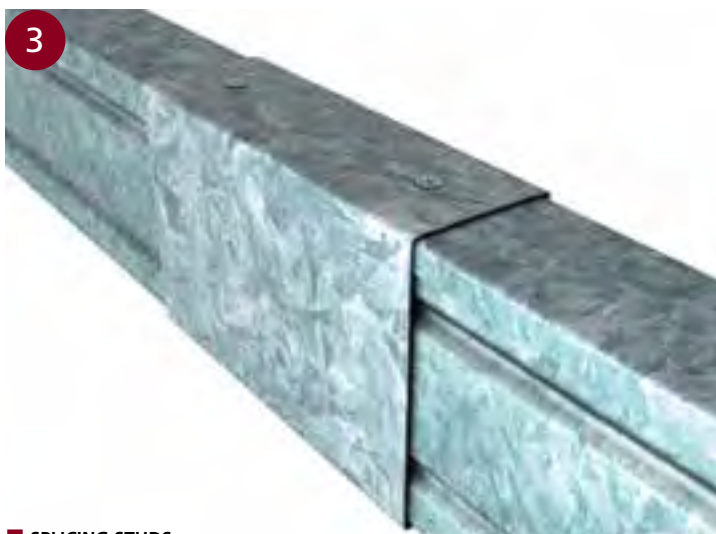

■ SPLICING STUDS

*The following installation details are based on using the Rondo 112 Stud 64 x 0.50BMT profile.*

## STEP ONE

The Rondo steel stud sections will require boxing.

Looking at the end profile, note that one flange leg is 2mm longer than the other. In order to box the studs, position them so that the shorter flange leg of one stud fits inside the longer leg of the other. Then squeeze the studs together starting at one end and working along the full length of the studs. The studs now form a box section as shown in Figure 1.

## STEP TWO

The structural suspension fixings should now be installed and set out in a 1200 x 1200mm grid pattern.

The 8mm threaded rod hangers, once cut to the appropriate length, are then secured to your structural fixings. One M8 nut should then be spun onto the end of each threaded rod hanger at a distance of 90mm.

## STEP THREE

Place the Rondo Part # 271 'U' Brackets onto the boxed stud section and attach to the threaded hanger rods with another M8 nut beneath the bracket. The primary studs are then secured to the threaded rod hangers as in Figure 2.

## STEP FOUR

If joining studs is required, they should be spliced end to end with short pieces of Rondo 111 64mm Track screwed into each end of the stud top and bottom as in Figure 3.

## STEP FIVE

When the full primary stud assembly has been completed it will be necessary to level the system using a suitable leveling device such as a laser. Adjusting the two nuts on each hanger 'U' Bracket will ensure the system is leveled and the nuts should be secured tightly.

#### STEP SIX

The secondary boxed stud assembly should now be installed at 90° to the primary studs and spaced 1200mm apart on top of the primary stud assembly. The secondary stud assembly is secured to the primary studs with the Rondo 270 Angle Bracket using two screws through the bracket to each stud as shown in Figure 4.

#### STEP SEVEN

Rondo Furring Channel can now be attached to the underside of the system by placing the Rondo 224 Furring Channel Clip over the lower primary stud assembly and clipping the Furring Channel into place as shown in Figure 5. Once the Furring Channel is installed the clip cannot be removed.

Similarly, a full Rondo KEY-LOCK® Concealed Ceiling System for building board can be installed using either direct fix or suspension methods as detailed on pages 11 and 16 of this Design Manual, where the primary stud assembly is used as a purlin.

The same applies to the installation of a Rondo DUO® Exposed Grid Ceiling System.

#### STEP EIGHT

The system is now ready for the installation of the platform or walkway to be positioned onto the primary stud framework to both coincide with any framework to both coincide with any personnel access panels and adjacent to any mechanical or electrical equipment.

#### STEP NINE

Once the platforms are in place and properly secured and after a final check of the level the ceiling board can be attached to the Furring Channel in accordance with the board manufacturers recommendations.

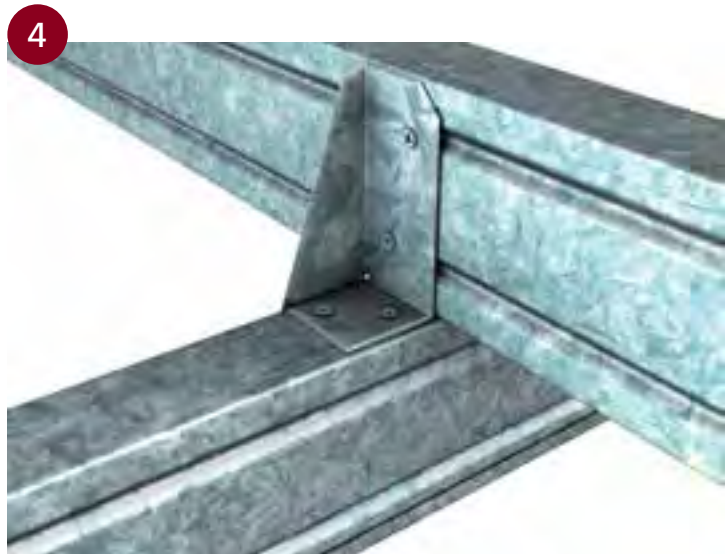

■ INSTALLATION OF THE SECONDARY PRIMARY SYSTEM



■ ATTACHING THE FURRING CHANNELS

#### PLEASE NOTE:

If access panels are to be installed in the ceiling, these must be the type of panel that allow safe access into the plenum space by service personnel. The standard Access Panels in Rondo's PANTHER® range are not designed as personnel access panels.



# STEEL STUD DRYWALL CEILING SYSTEMS

Steel studs may be used as ceiling joists, especially in situations where it is difficult to install a suspended ceiling.

Typical applications would be corridors, bathrooms or open roof areas. The tables starting on page 75 set out the maximum spans for Rondo steel studs.

They also show the minimum rows of bridging. Bridging in a ceiling serves the same purpose as Noggings in a wall.

The maximum ceiling span tables have been formulated using dead load plus 0.25kPa negative internal pressure.

Deflection has been checked to Span/480. The studs have been checked for bending and shear over the supports.

Where Access Panels are placed in the ceiling, the joists supporting the Access Panel must be strengthened to allow for maintenance loads.

The ceiling span tables are applicable for internal non-trafficable ceilings only.

Where ceilings are external or subject to wind loads they should be checked by Rondo, or a structural engineer prior to commencement of work.

## CONTENTS:

INSTALLATION GUIDE 70

INSTALLATION DETAILS

• MECHANICAL JOINTS 71

• FRICTION JOINTS 72

BULKEADS 74

SPAN TABLES 75

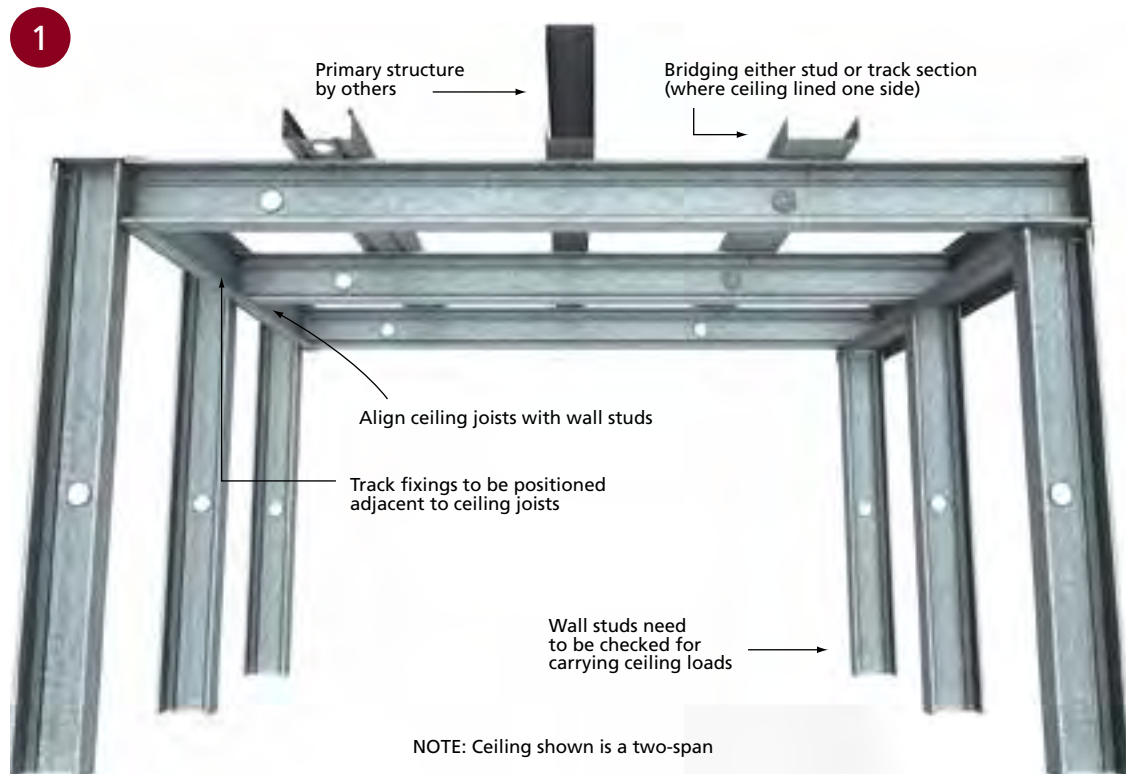

■ TYPICAL CEILING APPLICATION



# INSTALLATION GUIDE

## STEP ONE

Set out the track locations in accordance with the ceiling levels, as shown on the architectural drawings.

## STEP TWO

Secure the perimeter tracks in position using appropriate fasteners at not more than 600mm centres.

The track fixings should be no more than 50mm from the stud locations.

## STEP THREE

Cut the studs to length – this will be 10mm shorter than the span length.

NOTE: Heavier gauge studs can be cut using abrasive wheels fitted to circular saws.

## STEP FOUR

Fit the studs into the perimeter tracks, then with a twisting action rotate the studs into position.

Ideally, the studs should be orientated in the same direction to make fitting the lining board easier.

## STEP FIVE

Fit the bridging members at the centres specified.

Ensure the stud spacing is maintained when fitting the bridging members.

## STEP SIX

Fit intermediate connections for multiple span ceiling joists. Ensure the fixings are tight and any deflection of the studs is taken up at this time.

## STEP SEVEN

Fit the lining board to the studs. The lining board should be fitted such that the board is screwed to the open side of the stud first. This will prevent any misalignment of the board along the ceiling.

## STEP EIGHT

Set the joints in the lining board and fit the cornice.

# INSTALLATION DETAILS

## Stud & Track Joints: Mechanical Joints

Mechanical joints are required where the maximum spans of the ceiling exceeds those allowable for friction joints, or where a more positive connection is required (see Figure 2).

Mechanical joint Type 1 is suitable for single span ceilings up to 3000mm or two or three span ceilings up to 4000mm span.

A fastener should be used to the top and bottom of the stud and track where possible.

Mechanical joints Type 2 and 3 are used where larger spans are necessary (see Figures 3 & 4).

Where doubt exists, we suggest your local Rondo Technical Sales Representative be consulted for further design advice.

### NOTES:

- a) Where the ceiling intersects a stud wall, the wall must be checked for the ceiling load.
- b) The plasterboard manufacturers recommend a continuous backing angle should be installed behind the wall/ceiling joint.

2

Suitable masonry anchors installed to manufacturer's specification

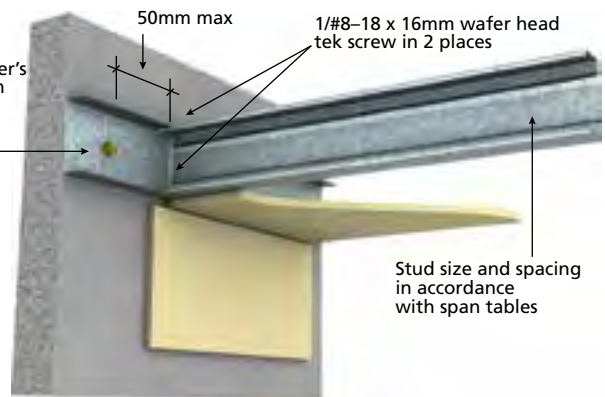

Stud size and spacing in accordance with span tables

MECHANICAL JOINT TYPE 1

3

Minimum spacing in accordance with manufacturer's specification

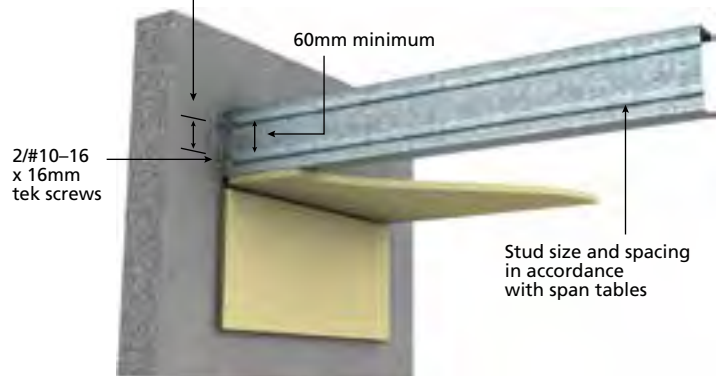

Stud size and spacing in accordance with span tables

MECHANICAL JOINT TYPE 2

4

3/#10-16 x 16mm tek screws or equivalent

Fix to web of stud only

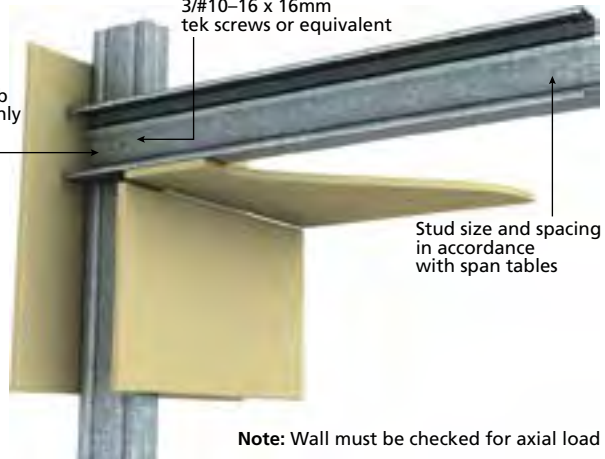

Stud size and spacing in accordance with span tables

Note: Wall must be checked for axial load

MECHANICAL JOINT TYPE 3

# INSTALLATION DETAILS (continued)

## Stud & Track Joints: Friction Joints

Friction joints provide allowance for movement of building elements. These joints rely on the friction between the stud and track sections to secure the ceiling joists.

It is not recommended to use this type of joint where vibration or mechanical equipment is used in close proximity to the ceiling. The maximum span for these ceilings is 2000mm for single spans and 2800mm for two or more spans.

Studs supporting access panels and in the local vicinity must be mechanically fastened.

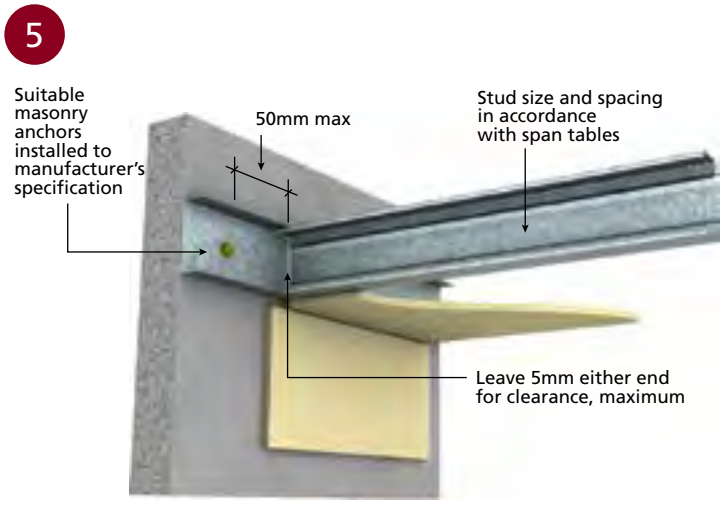

■ FRICTION JOINT

## Ceiling Support Details

When two span or three span continuous studs are used it is necessary to provide additional fixing points within the span of the studs (refer to *Installation Details on page 70*).

### SUSPENSION JOINTS

These fixing points may be constructed using hoop iron strapping wrapped around the underside of the stud and fixed to the web of the roof purlin as shown in Figure 6, Suspension Joint Type 1.

To be effective, the strapping must be pulled tight before fixing off the loose end of the strap.

Alternatively, Angle Brackets, typically Rondo 553 Angle, may be used to connect to the studs as shown in Figure 7, Suspension Joint Type 2.

When connecting to concrete soffits, angle connectors can be used to make the stud connections as shown in Figure 8, Suspension Joint Type 3.

### SPLICE DETAILS

Studs should be spliced/joined over a supporting member. Splicing of the studs should be over a minimum of 300mm for the 0.50, 0.55 and 0.75bmt sections. The 1.15bmt studs cannot be spliced in ceiling systems as the ceiling setout changes.



■ SUSPENSION JOINT TYPE 1

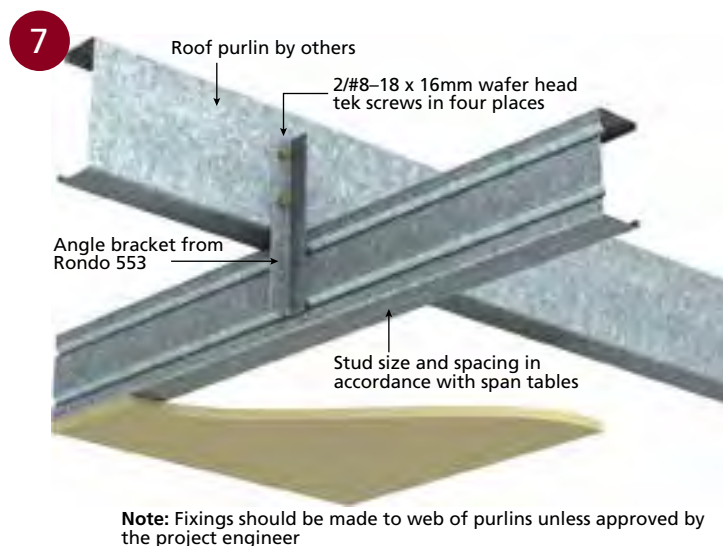

■ SUSPENSION JOINT TYPE 2

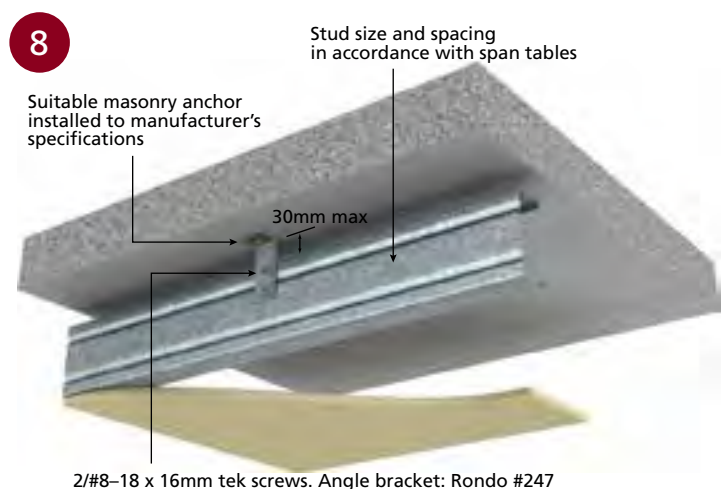

■ SUSPENSION JOINT TYPE 3

# BULKHEADS

Where the bulkhead drop exceeds 600mm it starts to become difficult to use Furring Channels to form the bulkheads, and when the drop exceeds 1200mm steel studs are recommended.

Bulkheads require independent suspension to carry the additional plasterboard and framing members. This may be achieved by fixing the framing members directly to the structural soffit or alternatively, providing additional suspension hangers to the bulkhead.

All bulkheads require bracing to provide lateral stability to the framework during incidental loading. This may be achieved by providing stud bracing, fixed diagonally between the bulkhead framework and the structural soffit at regular intervals, or alternatively, by rigidly coupling the ceiling to the bulkhead.

Where the ceiling is coupled to the bulkhead, the termination points require special detailing and the ceiling must be checked for the horizontal load. Details of this may be sought from Rondo.

For the 'box type' bulkheads (refer Figure 10), the stud size and spacing depends on the span and drop. Details of specific configurations may be sought from Rondo.

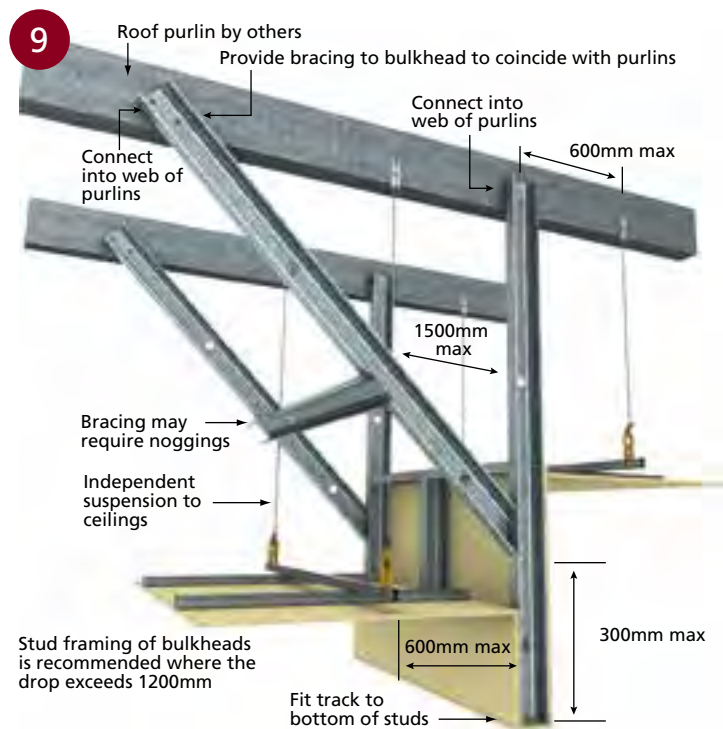

■ PROJECTION BULKHEAD

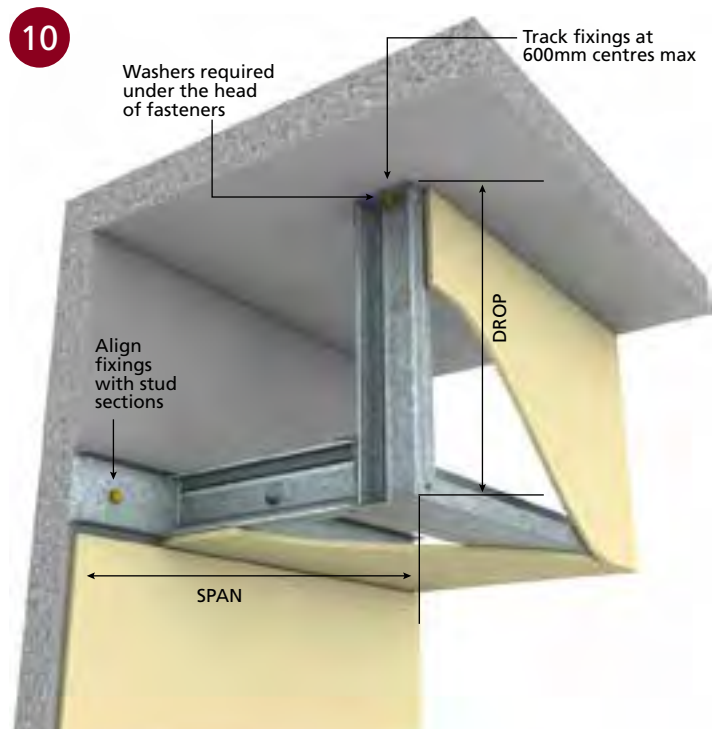

■ BOX-TYPE BULKHEAD

# SPAN TABLES: STEEL STUD CEILING SYSTEMS

Single Span



TABLE 10: SINGLE SPAN CEILING JOISTS

STUD WIDTH	51mm		64mm			76mm			92mm			150mm	
BMT	0.50	0.75	0.50	0.75	1.15	0.55	0.75	1.15	0.55	0.75	1.15	0.75	1.15
<b>PLASTERBOARD LININGS (mm)</b>	<b>SINGLE STUDS @ 600mm CENTRES / BOXED OR BACK TO BACK @ 1200mm CENTRES</b>												
1 x 10mm	1835	2060	2145	2460	2775	2535	2820	3185	2935	3255	3680	4750	5380
1 x 13mm	1800	2020	2100	2530	2785	2580	3005	3125	2870	3290	3615	4660	5285
1 x 16mm	1740	1960	2095	2470	2705	2500	2945	3025	2780	3195	3495	4510	5120
2 x 13mm	1665	1880	1945	2335	2575	2365	2770	2900	2660	3030	3355	4325	4915
2 x 16mm	1580	1780	1860	2235	2450	2235	2650	2760	2525	2875	3190	4115	4675
<b>PLASTERBOARD LININGS (mm)</b>	<b>SINGLE STUDS @ 450mm CENTRES</b>												
1 x 10mm	2010	2260	2350	2695	3035	2780	3090	3480	3210	3565	4020	5190	5860
1 x 13mm	1975	2220	2305	2760	3045	2845	3265	3415	3165	3605	3975	5095	5760
1 x 16mm	1910	2150	2305	2690	2960	2760	3200	3310	3050	3505	3845	4935	5585
2 x 13mm	1830	2060	2140	2550	2820	2615	3015	3175	2920	3330	3680	4740	5370
2 x 16mm	1735	1950	2080	2440	2690	2480	2895	3020	2775	3170	3495	4505	5115
<b>PLASTERBOARD LININGS (mm)</b>	<b>SINGLE STUDS @ 400mm CENTRES</b>												
1 x 10mm	2090	2350	2445	2800	3145	2885	3205	3605	3335	3700	4165	5380	6065
1 x 13mm	2050	2300	2395	2855	3150	2955	3375	3540	3300	3740	4125	5285	5960
1 x 16mm	1985	2230	2395	2785	3065	2870	3310	3430	3185	3635	3995	5120	5785
2 x 13mm	1900	2140	2220	2645	2925	2720	3120	3295	3035	3460	3825	4915	5560
2 x 16mm	1805	2030	2160	2530	2790	2585	2995	3135	2880	3295	3630	4675	5300
<b>PLASTERBOARD LININGS (mm)</b>	<b>SINGLE STUDS @ 300mm / BOXED OR BACK TO BACK @ 600mm CENTRES</b>												
1 x 10mm	2290	2570	2675	3060	3430	3160	3505	3930	3650	4040	4535	5865	6580
1 x 13mm	2250	2520	2625	3105	3430	3230	3655	3860	3635	4075	4500	5760	6475
1 x 16mm	2175	2440	2620	3030	3340	3145	3585	3745	3520	3970	4370	5585	6285
2 x 13mm	2085	2340	2435	2880	3190	2980	3390	3600	3355	3780	4185	5370	6055
2 x 16mm	1980	2230	2375	2755	3045	2845	3255	3430	3175	3605	3985	5115	5775
<b>PLASTERBOARD LININGS (mm)</b>	<b>SINGLE STUDS @ 1200mm CENTRES</b>												
1 x 10mm	1460	1650	1695	1965	2225	2020	2255	2555	2310	2605	2955	3530	4335
1 x 13mm	1430	1610	1665	1925	2180	1980	2210	2505	2255	2555	2900	3480	4255
1 x 16mm	1385	1560	1615	1865	2110	1815	2135	2420	2160	2470	2805	3375	4115
2 x 13mm	1325	1490	1545	1785	2020	1755	2045	2320	1895	2365	2685	3240	3730
2 x 16mm	1255	1420	1450	1695	1915	1675	1935	2205	1820	2245	2550	3075	3590

MINIMUM BRIDGING REQUIREMENTS		
CEILING SPAN (m)	LINING CONDITION	NO. BRIDGING
0 – 2.0	Lined one side	0
2.0 – 4.0		1
4.0 – 6.0		2
6.0 – 7.0		3

**NOTES:**

- Strength check:  $1.2G + Wu$ , using  $Wu = 0.375kPa$
- Serviceability check:  $G + Ws$  Limit  $L / 360$  or  $12mm$ ,  $G$  Limit  $L/600$
- Support walls and connections to be independently checked.
- The live load in accordance with AS/NZS1170.1:2002 Clause 3.5.2 has not been applied to the ceiling joists. Accordingly, personnel are not permitted to traffic the ceiling joists.
- Maximum span tables assume Noggings are equally spaced along studs.

# SPAN TABLES: STEEL STUD CEILING SYSTEMS (continued)

Continuous Span



TABLE 11: CONTINUOUS SPAN CEILING JOISTS

STUD WIDTH	51mm		64mm			76mm			92mm			150mm	
BMT	0.50	0.75	0.50	0.75	1.15	0.55	0.75	1.15	0.55	0.75	1.15	0.75	1.15
<b>PLASTERBOARD LININGS (mm)</b>	<b>SINGLE STUDS @ 600mm CENTRES / BOXED OR BACK TO BACK @ 1200mm CENTRES</b>												
1 x 10mm	2380	2770	2480	3290	3710	2920	3780	4260	3240	4220	4930	5390	7200
1 x 13mm	2330	2710	2420	3240	3650	2850	3710	4180	3170	4120	4840	5260	7040
1 x 16mm	2230	2620	2310	3130	3530	2730	3550	4050	3030	3950	4690	5050	6760
2 x 13mm	2110	2510	2190	3000	3380	2590	3360	3890	2870	3730	4500	4780	6410
2 x 16mm	1960	2390	2040	2840	3210	2410	3140	3690	2680	3490	4270	4470	6000
<b>PLASTERBOARD LININGS (mm)</b>	<b>SINGLE STUDS @ 450mm CENTRES</b>												
1 x 10mm	2690	3030	2850	3610	4070	3360	4140	4670	3730	4770	5390	6170	7850
1 x 13mm	2640	2970	2780	3580	3990	3280	4150	4580	3640	4690	5290	6030	7710
1 x 16mm	2560	2880	2660	3460	3860	3140	4020	4430	3490	4530	5120	5730	7480
2 x 13mm	2420	2760	2520	3300	3710	2980	3820	4250	3300	4290	4920	5480	7190
2 x 16mm	2260	2620	2350	3120	3520	2780	3600	4050	3080	4010	4680	5130	6850
<b>PLASTERBOARD LININGS (mm)</b>	<b>SINGLE STUDS @ 400mm CENTRES</b>												
1 x 10mm	2800	3150	3020	3750	4210	3560	4290	4830	3950	4950	5580	6520	8120
1 x 13mm	2750	3090	2950	3720	4140	3470	4320	4740	3850	4860	5480	6370	7990
1 x 16mm	2650	2990	2820	3600	4010	3330	4180	4600	3690	4710	5310	6110	7750
2 x 13mm	2540	2870	2670	3440	3850	3150	3980	4410	3490	4520	5100	5740	7450
2 x 16mm	2400	2720	2490	3250	3660	2940	3760	4200	3260	4240	4850	5420	7100
<b>PLASTERBOARD LININGS (mm)</b>	<b>SINGLE STUDS @ 300mm / BOXED OR BACK TO BACK @ 600mm CENTRES</b>												
1 x 10mm	3070	3440	3470	4100	4590	4080	4700	5270	4520	5410	6070	7340	8770
1 x 13mm	3010	3380	3380	4080	4510	3990	4730	5170	4420	5310	5970	7200	8660
1 x 16mm	2910	3270	3240	3950	4370	3820	4600	5010	4240	5150	5790	6970	8480
2 x 13mm	2790	3140	3070	3780	4200	3620	4370	4820	4010	4940	5570	6620	8240
2 x 16mm	2650	2990	2870	3590	4000	3380	4160	4590	3750	4700	5300	6210	7910
<b>PLASTERBOARD LININGS (mm)</b>	<b>SINGLE STUDS @ 1200mm CENTRES</b>												
1 x 10mm	1690	2020	1760	2450	2980	2080	2710	3420	2310	3010	3910	3860	5200
1 x 13mm	1650	1980	1720	2390	2920	2030	2640	3350	2250	2940	3830	3770	5080
1 x 16mm	1580	1910	1640	2290	2820	1940	2530	3240	2160	2810	3700	3610	4860
2 x 13mm	1490	1830	1550	2160	2700	1840	2390	3110	2040	2660	3510	3380	4600
2 x 16mm	1390	1730	1450	2020	2570	1710	2230	2930	1890	2480	3280	3110	4300

MINIMUM BRIDGING REQUIREMENTS		
CEILING SPAN (m)	LINING CONDITION	NO. BRIDGING
0 – 2.0	Lined one side	0
2.0 – 4.0		1
4.0 – 6.0		2
6.0 – 7.0		3

**NOTES:**

1. Strength check:  $1.2G + W_u$ , using  $W_u = 0.375kPa$
2. Serviceability check:  $G + W_s$  Limit  $L / 360$  or  $12mm$ ,  $G$  Limit  $L/600$
3. Support walls and connections to be independently checked.
4. The live load in accordance with AS/NZS1170.1:2002 Clause 3.5.2 has not been applied to the ceiling joists. Accordingly, personnel are not permitted to traffic the ceiling joists.
5. Refer to Rondo for splice details where multiple span length exceeds single stud length. The above table assumes continuity.
6. Maximum span tables assume Noggings are equally spaced along studs.