



RONDO
ACOUSTIC WALL & CEILING
SYSTEMS MANUAL

SEPTEMBER 2015

RONDO®

INTRODUCTION

This manual provides information on the performance of the Rondo range of acoustic products when incorporated in common installation scenarios and includes compliant systems for the Australian National Construction Code (NCC) and New Zealand Building Codes (NZBC) for acoustic insulation criteria. This information will assist engineers and designers in meeting the building code acoustic requirements with confidence, when using the Rondo acoustic range.

Rondo commissioned acoustic experts, Norman Disney & Young Acoustic Services to advise, monitor and analyse an extensive programme of airborne sound and impact insulation tests.

Testing was carried out at the laboratories of the University of Auckland, New Zealand, and CSIRO at Highett, Victoria. This manual incorporates those tests, where applicable.

Rondo has also reproduced relevant test data on some systems where applicable.

In combination, the test data and opinions produced by Norman Disney & Young (NDY) form the basis of this manual. Based on the available test data, this manual provides you with an understanding of what performance you may expect from a Rondo acoustic product and presents you with a number of NDY opinions to help you make the right decision.

SUITABLE FOR

Rondo Wall and Ceiling Systems as detailed throughout this manual.

SPECIAL FEATURES

- NCC and NZBC Compliant Acoustic Systems for both walls and ceilings.
- Consideration of Airborne & Impact Sound Performance.
- Compatibility with each Rondo System.

IN PRACTICE

Rondo's Acoustic Wall & Ceiling Systems have been used across iconic projects including *Clyde Quay Wharf in Wellington* and *Sudima Hotel in Christchurch, New Zealand*, as well as *The Milton apartments in Brisbane, Australia*.

IMPORTANT NOTE:

Rondo recommends its products and systems are installed by a qualified tradesperson and according to the relevant codes and standards.

Rondo recommends that before acting on any advice or opinion in this manual, you should seek professional advice in light of your own architectural and building requirements.

CONTENTS:

BACKGROUND

BUILDING CODE ACOUSTIC CRITERIA	2
IMPORTANCE OF AIRBORNE & IMPACT SOUND INSULATION	2
CONSTRUCTION DETAILS TO MAXIMISE ACOUSTIC PERFORMANCE	3
MATERIALS USED IN CONSTRUCTION OF TEST SUBJECTS	3
AVAILABILITY OF FULL TEST DATA	3

CEILING SYSTEMS

UNDER CONCRETE SLABS 4

CEILING SYSTEMS

UNDER TIMBER JOISTS 7

QUIET STUD®

SOUND INSULATION SYSTEM 10

TIMBER STUD WALLS 13

MASONRY WALL SYSTEMS 15

RONDO STDC RESILIENT MOUNT 17

STANDARDS FOR MEASUREMENTS 18

ACKNOWLEDGEMENTS 19

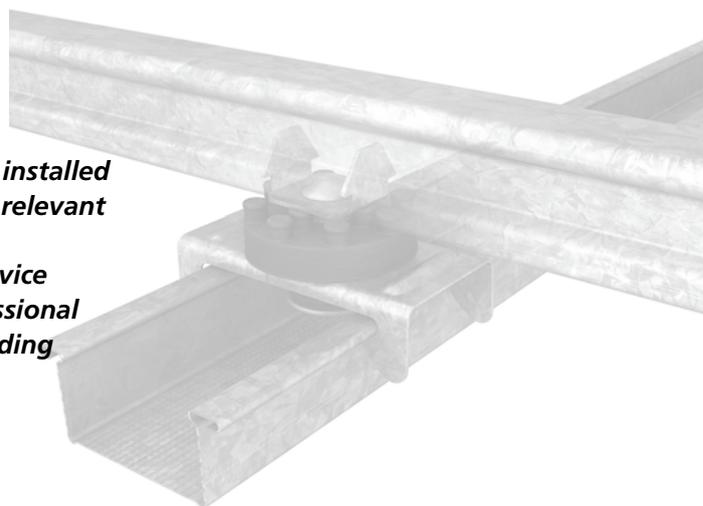

BACKGROUND

BUILDING CODE ACOUSTIC CRITERIA

The primary aim of this Acoustic Manual is to demonstrate how Rondo resilient acoustic products can assist in achieving compliance with the NCC and the NZBC.

To provide a degree of control over the quality of residential development projects, the NCC and the NZBC impose minimum sound and impact insulation ratings with which it is a legal requirement to comply.

The table below summarises the relevant acoustic criteria set out within these codes. These criteria form the basis of our analysis, against which the available system test data has been compared.

TYPE	CRITERIA	TYPICAL APPLICATION
AUSTRALIAN NATIONAL CONSTRUCTION CODE (NCC)		
Airborne Sound Insulation	$R_w + C_{tr} \geq 50$	A wall or floor separating Sole Occupancy Units (SOUs)
	$R_w \geq 50$	A wall separating a dwelling from a stairway, public corridor, public lobby, etc.
Impact Sound Insulation	$L_{n,w} + C_i \leq 62$	A floor separating SOUs
NEW ZEALAND BUILDING CODE (NZBC)		
Airborne Sound Insulation	$STC \geq 55$	A wall or floor separating habitable rooms
Floor Impact Sound Insulation	$IIC \geq 55$	A floor separating occupancies

IMPORTANCE OF AIRBORNE SOUND & IMPACT SOUND INSULATION

There are two important acoustic aspects to consider when designing and constructing any building project where protection against external noise is desirable. These two aspects are called airborne sound insulation and impact sound insulation, and they apply to the building elements which form the boundaries of any room.

Airborne sound insulation is described as the ability of a building element to reduce the sound transmission through it, from one side to the other. For instance, the airborne sound insulation properties of a wall dictate how much speech you would hear coming through the wall from a neighbouring room. It is normally expressed as a single value, R_w or STC, and the higher the number, the better the performance.

Impact sound insulation, conversely, is the resistance of a building element to sound transmission through it, but where the noise source is an impact on the surface of the element providing the insulation. For instance, the impact insulation properties of a floor dictates how much footfall you would hear through the floor from a room above. For Australia, it is normally expressed as a single value, $L_{n,w} + C_i$, and the lower the number, the better the performance. For New Zealand, it is normally expressed as a single value, IIC, and the higher the number, the better the performance.

Providing good airborne and impact sound insulation is important for many situations such as in apartments, educational facilities, hospitals, offices, etc. Excessive noise intrusion from adjacent spaces can cause nuisance, sleep disturbance and poor speech intelligibility.

CONSTRUCTION DETAILS TO MAXIMISE ACOUSTIC PERFORMANCE

Attention to detail is a crucial part of achieving the best acoustic performance out of any wall or floor system. Ways to avoid the most common issues arising during construction, which can degrade the airborne or impact sound insulation of a particular wall or floor systems include:

- Seal all gaps, penetrations and the perimeter of the wall or ceiling with non-shrink mastic sealant
- Avoid bridging out resilient clips with other items or equipment in the ceiling voids or wall cavities, e.g. pipes, air conditioning units, power points, etc.
- Install insulation evenly across the entire ceiling and through all cavities in walls
- In ceilings, do not under or overload the resilient elements. A minimum of 3mm deflection and a maximum of 5mm should be achieved from the resilient element due to the ceiling weight
- In walls, use the minimum number of resilient clips possible to achieve sufficient structural support of the wall linings. This maximises the resilience or springiness of the furred-off wall lining
- Avoid back-to-back service penetrations in walls wherever possible

LABORATORY TESTING AND ON-SITE PERFORMANCE

The test data referenced in this publication has been gathered from controlled laboratory testing. It should be remembered that this data can be 'degraded' by 'on-site' conditions such as the installation of lighting and air conditioning registers in ceilings, and the position and number of power points in walls.

MATERIALS USED IN THE CONSTRUCTION OF TEST SUBJECTS

Laboratory testing carried out by Rondo was conducted in accordance with the relevant standards and in consultation with Acoustic Consultants, Norman Disney & Young (see page 18 for full details).

Particular materials were chosen to comply with specific thickness, density, type and overall dimensional requirements to obtain appropriate test data using Rondo's acoustic components.

With the exception of specific tests, which were carried out by others, Rondo has not identified particular manufacturer's products in its results.

Notwithstanding this, it is important that wall lining mass and insulation density is maintained to achieve the required performance.

AVAILABILITY OF FULL TEST DATA

The information published in this manual is, by necessity, simplified and provides basic system specifications together with the overall acoustic ratings relevant to the code compliance requirements.

Rondo will supply full test data for analysis by acoustic engineers and architects, at its discretion, for the tests which Rondo has commissioned. For external test results, Rondo will forward requests for such information to the relevant holders of the information.

Enquiries should be forwarded to your local Rondo Technical Sales Representative or by filling out an enquiry form at www.rondo.com.au/acoustic.

CEILING SYSTEMS UNDER CONCRETE SLABS

This section provides solutions for the Rondo Resilient Acoustic Mounts when used with the Rondo KEY-LOCK® Concealed Suspended Ceiling System and multi-layer plasterboard linings when suspended or directly fixed beneath a concrete slab. These systems comply with the relevant NCC and NZBC Codes as identified.

STSU:

Sound isolation mount installed between the Rondo Primary/Top Cross Rail and the Rondo Furring Channel for suspended ceiling applications. Provides acoustic separation between the ceiling linings and the supporting framework.



STSL

Sound isolation mount installed directly to the underside of a concrete slab to accept Rondo Furring Channel incorporating various sized 'through bolt' anchors to suit the application. Provides acoustic and vibration separation between the ceiling system and the supporting structure.



WHI

Suspension rod hanger isolator installed within the Rondo KEY-LOCK® Concealed Suspended Ceiling System. Available in different grades to suit varying loads. Provides acoustic and vibration separation between the ceiling system and the supporting structure.



In the following tables, the relevant NCC and NZBC complying rating values are given for the nominated systems. **The complying values are shown in green.**

We have also provided alternative systems determined by NDY which, in their opinion, are compliant with the NCC & NZBC minimum sound and impact insulation requirements.

It should be noted that lateral impact transmission

may not be adequately controlled if a bare slab solution is adopted.

This is not specifically outlined as a requirement of the NCC or NZBC, but is an important consideration to limit neighbour complaints.

A suitably qualified acoustic engineer should be consulted for further advice.

Note: The Australian NCC ratings have a grey background and the NZBC pink.

1. SUSPENDED SYSTEM WITH RONDO STSU FURRING CHANNEL CLIP

TEST ID	SYSTEM DIAGRAM	SYSTEM DESCRIPTION	SYSTEM RATING	
(T1401-4a) (T1401-4i)		<ul style="list-style-type: none"> • 125mm concrete slab • Suspended ceiling with 150mm cavity depth • 50mm partition batts (11kg/m³) • Rondo KEY-LOCK® system: 129 Furring Channels at 600mm centres, 127 Top Cross Rails at 1200mm centres • STSU Furring Channel Clip • 1 x 13mm standard plasterboard (8.5kg/m² each layer) 	$R_w + C_{tr}$	51
			$L_{n,w} + C_l$	53
			STC	64
			IIC	44

2. SUSPENDED SYSTEM WITH RONDO WHI RESILIENT HANGER ELEMENT

TEST ID	SYSTEM DIAGRAM	SYSTEM DESCRIPTION	SYSTEM RATING	
(T1401-2a) (T1401-2i)		<ul style="list-style-type: none"> • 125mm concrete slab • Suspended ceiling with 230mm cavity depth • 50mm partition batts (11kg/m³) • WHI Green Resilient Hanger Element • Rondo KEY-LOCK® system: 129 Furring Channels at 600mm centres, 127 Top Cross Rails at 1200mm centres • Standard furring channel clip • 1 x 13mm standard plasterboard (8.5kg/m² each layer) 	$R_w + C_{tr}$	55
			$L_{n,w} + C_l$	50
			STC	67
			IIC	43

3. NDY OPINION WITH SUSPENDED SYSTEM AND RONDO STSU FURRING CHANNEL CLIP

TEST ID	SYSTEM DIAGRAM	SYSTEM DESCRIPTION	SYSTEM RATING	
A-FCSus- STSU-Opinion I-FCSus- STSU-Opinion		<ul style="list-style-type: none"> • 150mm concrete slab • Suspended ceiling with 250mm cavity depth • 50mm partition batts (11kg/m³) • Rondo KEY-LOCK® system: 129 Furring Channels at 600mm centres, 127 Top Cross Rails at 1200mm centres • STSU Furring Channel Clip • 2 x 13mm fire-rated plasterboard (10kg/m² each layer) 	$R_w + C_{tr}$	55
			$L_{n,w} + C_l$	49
			STC	60
			IIC	55

CEILING SYSTEMS UNDER CONCRETE SLABS (continued)

4. DIRECT FIX SYSTEM WITH RONDO STSL FURRING CHANNEL CLIP ASSEMBLY WITH 6mm ANCHOR BOLT

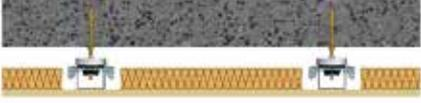
TEST ID	SYSTEM DIAGRAM	SYSTEM DESCRIPTION	SYSTEM RATING	
(T1401-7a) (T1401-7i)		<ul style="list-style-type: none"> • 125mm concrete slab • 50mm partition batts (11kg/m³) • STSL Furring Channel Clip with 85mm long through bolt masonry anchor at 1200mm centres • Rondo 129 Furring Channels at 600mm centres • 1 x 13mm standard plasterboard (8.5kg/m² each layer) 	R _w + C _{tr}	50
			L _{n,w} + C _l	54
			STC	66
			IIC	41*

*NOTE: With respect to the NZBC Impact (IIC) rating requirement of ≥55, it is not generally practical or cost efficient to build an exposed concrete floor/ direct fix ceiling system that would achieve the required impact acoustic rating.

It is therefore recommended that consideration be given to an acoustic treatment of the floor above. Furthermore, it is suggested that the above systems would comply with the NZBC Impact Rating if an appropriate acoustical treatment of the floor above was undertaken.

CEILING SYSTEMS UNDER TIMBER JOISTS

This section provides solutions for the Rondo Resilient Acoustic Mounts when used with the Rondo KEY-LOCK® Concealed Suspended Ceiling System and multi-layer plasterboard linings when suspended or directly fixed beneath a timber floor. These systems comply with the relevant NCC and NZBC Codes as identified.

STSU:

Sound isolation mount installed between the Rondo Primary/Top Cross Rail and the Rondo Furring Channel for suspended ceiling applications. Provides acoustic separation between the ceiling linings and the supporting framework.



STPC:

Sound isolation mount installed directly to timber or steel joists to accept the Rondo Furring Channel. Provides acoustic and vibration separation between the ceiling system and the supporting structure.



CEILING SYSTEMS UNDER TIMBER JOISTS (continued)

The following system specifications have been assessed by NDY, based upon available data, and in their opinion are compliant with the NCC and NZBC minimum sound and impact insulation requirements. **The complying values are shown in green.**

Note: The Australian NCC ratings have a grey background and the NZBC pink.

It should be noted that lateral impact transmission may not be adequately controlled if a bare timber flooring on joists solution is adopted.

This is not specifically outlined as a requirement of the NCC or NZBC, but is an important consideration to limit neighbour complaints.

A suitably qualified acoustic engineer should be consulted for further advice.

1. NDY OPINION WITH SUSPENDED SYSTEM AND RONDO STSU FURRING CHANNEL CLIP

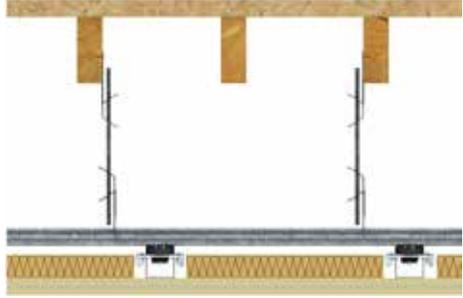
TEST ID	SYSTEM DIAGRAM	SYSTEM DESCRIPTION	SYSTEM RATING	
A-FTSus- STSU- Opinion I-FTSus-STSU- Opinion		<ul style="list-style-type: none"> • 25mm particle board (17kg/m² min.) • 190 x 45mm timber joists at 450mm min. centres • Suspended ceiling with 340mm cavity depth from underside of floor to top of ceiling plasterboard • 165mm fibreglass insulation (11kg/m³) • Rondo KEY-LOCK® 127 Top Cross Rails at 1200mm centres and 129 Furring Channels at 600mm centres • STSU Furring Channel Clip • 2 x 16mm fire-rated plasterboard (12.3kg/m² each layer min.) or 2 x 13mm sound-rated plasterboard (13kg/m² each layer min.) 	$R_w + C_{tr}$	50
			$L_{n,w} + C_1$	61
			STC	56
			IIC	47

2. NDY OPINION WITH DIRECT FIX SYSTEM AND RONDO STPC FURRING CHANNEL CLIPS WITH 25mm PARTICLE BOARD FLOORING

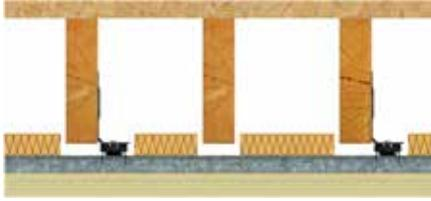
TEST ID	SYSTEM DIAGRAM	SYSTEM DESCRIPTION	SYSTEM RATING	
A-FTDir- STPC-Opinion I-FTDir-STPC- Opinion		<ul style="list-style-type: none"> • 25mm particle board (17kg/m² min.) • 190 x 45mm timber joists at 450mm min. centres • Rondo 129 Furring Channel direct fix ceiling with furring channels spaced 600mm apart with 240mm cavity depth from underside of floor to top of ceiling plasterboard • 165mm fibreglass insulation (11kg/m³) • STPC Furring Channel Clip at 900mm centres • 3 x 13mm fire-rated plasterboard (10kg/m² each layer min.) 	$R_w + C_{tr}$	50
			$L_{n,w} + C_1$	62
			STC	56
			IIC	46

3. NDY OPINION WITH DIRECT FIX SYSTEM AND RONDO STPC FURRING CHANNEL CLIPS WITH 19 or 22mm PARTICLE BOARD FLOORING

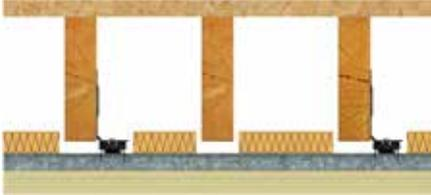
TEST ID	SYSTEM DIAGRAM	SYSTEM DESCRIPTION	SYSTEM RATING	
A-FTDir-STPC-Opinion2 I-FTDir-STPC-Opinion2		<ul style="list-style-type: none"> • 19 or 22mm particle board (15kg/m² min.) • 190 x 45mm timber joists at 450mm min. centres • Rondo 129 Furring Channel direct fix ceiling with furring channels spaced 600mm apart with 240mm cavity depth from underside of floor to top of ceiling plasterboard • 165mm fibreglass insulation (11kg/m³) • STPC Furring Channel Clip at 900mm centres • 3 x 13mm fire-rated plasterboard (10kg/m² each layer min.) 	$R_w + C_{tr}$	50
			$L_{n,w} + C_l$	62
			STC	56
			IIC	46*

*NOTE: With respect to the NZBC Impact (IIC) rating requirement of ≥ 55 , it is not generally practical or cost efficient to build a bare timber floor/direct fix ceiling system that would achieve the required impact acoustic rating.

It is therefore recommended that consideration be given to an acoustic treatment of the floor above. Furthermore, it is suggested that the above systems would comply with the NZBC Impact Rating if an appropriate acoustical treatment of the floor above was undertaken.

QUIET STUD® SOUND INSULATION SYSTEM

RONDO QUIET STUD® ACOUSTIC SOUND SYSTEM

The Rondo QUIET STUD® System was introduced in 2004 and quickly proved to be an economic and practical way of achieving the acoustical requirements of both the NCC and NZBC.



The standard product manufactured from 0.55bmt steel has of course limitations in respect to achievable wall heights, however Rondo has now introduced a 0.75bmt version which addresses some of those issues whilst still achieving the minimum acoustical code requirements in both Australia and New Zealand. The following tables and test data revisit the benefits of the lighter gauge product whilst also providing acoustic performance figures for the new medium gauge product.

Contact your local Rondo Technical Sales Representative for maximum wall height tables for the new 0.75bmt Rondo QUIET STUD®.

For more information about Rondo QUIET STUD®, download a copy of the Rondo Professional Design Manual from the Rondo website.

CONTINUOUS AND DISCONTINUOUS CONSTRUCTION

It should be noted that the NCC deals with sound insulation between dwellings and nominates situations where discontinuous construction is required. The NCC defines discontinuous construction as meaning wall elements having a 20mm cavity between two separate leaves i.e. a double steel stud wall or similar with a 20mm cavity between the leaves.

The Rondo QUIET STUD® is considered a continuous construction and therefore may not generally be acceptable for walls between opposing sole occupancy units.

More specifically, Rondo QUIET STUD® is not acceptable for separating walls between habitable and non-habitable rooms in adjoining sole occupancy units.

The table below provides the relevant criteria.

SOUND INSULATION REQUIREMENTS OF THE NCC

CLASS	WALLS SEPARATING	$R_w + C_{TR}$	R_w	DISCONTINUOUS CONSTRUCTION REQUIRED
1	Habitable rooms (other than kitchens) of one building from a bathroom, laundry, kitchen, etc. in another Class 1 building	50	–	Yes
	Rooms between Class 1 buildings other than above	50	–	No
2 & 3	Habitable rooms (other than kitchens) of one SOU from a bathroom, laundry, kitchen etc. in another SOU	50	–	Yes
	Rooms between SOU's other than above	50		No
	SOU's from public corridor, stairway etc.	–	50	No
	SOU's from plant room or lift shaft	–	50	Yes
9c	SOU's from a kitchen or laundry	–	45	Yes
	SOU's from other SOU's (other than above), or from a sanitary compartment, bathroom, plant room etc.	–	45	No

NOTE: SOU = Sole Occupancy Unit

The tables below outline the system performance of both the original 0.55bmt Rondo QUIET STUD® and the new 0.75bmt Rondo QUIET STUD®.

Testing of the 0.55bmt stud was conducted at the CSIRO facility in Highett, Victoria. Testing of the new 0.75bmt stud, in conjunction with some additional testing of the 0.55bmt stud was carried out by Rondo at the University of Auckland.

We have also included test data relevant to the NZBC carried out and published by Winstone Wallboards (GIB®) in their current Noise Control Systems Manual dated March 2006. **The complying values are shown in green.**

Note: The Australian NCC ratings have a grey background and the NZBC pink.

1: 0.55bmt STEEL STUD TESTS

TEST ID	SYSTEM DIAGRAM	SYSTEM DESCRIPTION	SYSTEM RATING	
CSIRO TL434a		<ul style="list-style-type: none"> • 2 x 13mm fire-rated plasterboard each side (10.5kg/m² each layer) • Rondo 92 x 0.55bmt standard steel studs @ 600mm spacing • 100mm polyester insulation (14kg/m³) 	R _w + C _{tr}	43
			R _w	52
			STC	52
CSIRO TL434b		<ul style="list-style-type: none"> • 2 x 13mm fire-rated plasterboard each side (10.5kg/m² each layer) • Rondo 92 x 0.55bmt QUIET STUD® @ 600mm spacing • 100mm glasswool insulation (14kg/m³) 	R _w + C _{tr}	52
			R _w	57
			STC	54
CSIRO TL434c		<ul style="list-style-type: none"> • 2 x 13mm fire-rated plasterboard one side (10.5kg/m² each layer) • 1 x 13mm fire-rated plasterboard one side (10.5kg/m² each layer) • Rondo 92 x 0.55bmt QUIET STUD® @ 600mm spacing • 100mm glasswool insulation (14kg/m³) 	R _w + C _{tr}	48
			R _w	55
			STC	53
CSIRO TL434d		<ul style="list-style-type: none"> • 2 x 13mm fire-rated plasterboard each side (10.5kg/m² each layer) • Rondo 92 x 0.55bmt QUIET STUD® @ 600mm spacing • 100mm polyester insulation (14kg/m³) 	R _w + C _{tr}	51
			R _w	57
			STC	54
CSIRO TL434e		<ul style="list-style-type: none"> • 1 x 10mm sound-rated (8.2 kg/m² each layer) + 1 x 13mm fire-rated plasterboard (10.5kg/m² each layer) one side • 1 x 13mm fire-rated plasterboard (10.5kg/m² each layer) one side • Rondo 92 x 0.55bmt QUIET STUD® @ 600mm spacing • 100mm polyester insulation (14kg/m³) 	R _w + C _{tr}	44
			R _w	53
			STC	53
CSIRO TL434j		<ul style="list-style-type: none"> • 2 x 13mm standard plasterboard each side (8.6kg/m² each layer) • Staggered stud configuration with Rondo 92 x 0.55bmt top & bottom plate and Rondo 64 x 0.55bmt standard steel studs spaced 600mm each side • 100mm polyester insulation (14kg/m³) 	R _w + C _{tr}	51
			R _w	58
			STC	58

QUIET STUD SOUND INSULATION SYSTEM (continued)

2. QUIET STUD WALL TESTS CARRIED OUT BY WINSTONE WALLBOARDS RELEVANT TO NZBC (Data reproduced with the permission of Winstone Wallboards)

TEST ID	SYSTEM DIAGRAM	SYSTEM DESCRIPTION	SYSTEM RATING	
GBQSA 45		<ul style="list-style-type: none"> • 2 x 13mm GIB® standard plasterboard each side (8.5kg/m² each layer) • GIB® Rondo 92 x 0.55bmt QUIET STUD® @ 600mm spacing • R1.8 (75mm) Pink® Wall Batts® GW insulation (9.1kg/m³) 	STC	56
GBQSA 60a		<ul style="list-style-type: none"> • 1 x 13mm GIB Noiseline® (12.4kg/m² each layer) and 1 x 10mm GIB Noiseline® (8.8kg/m² each layer) Plasterboard one side with 1 x 13mm GIB Noiseline® Plasterboard the other side • GIB® Rondo 92 x 0.55bmt QUIET STUD® @ 600mm spacing • R1.8 (75mm) Pink® Wall Batts® GW insulation (9.1kg/m³) 	STC	56
GBQSA 90		<ul style="list-style-type: none"> • 1 x 13mm GIB Noiseline® (12.4kg/m² each layer) and 1 x 10mm GIB Noiseline® (8.8kg/m² each layer) Plasterboard to both sides • GIB® Rondo 92 x 0.55bmt QUIET STUD® @ 600mm spacing • R1.8 (75mm) Pink® Wall Batts® GW insulation (9.1kg/m³) 	STC	59

3: 0.75bmt STEEL STUD TESTS

TEST ID	SYSTEM DIAGRAM	SYSTEM DESCRIPTION	SYSTEM RATING	
T1401-17		<ul style="list-style-type: none"> • 2 x 13mm fire-rated plasterboard each side (9.5kg/m² each layer) • Rondo 92 x 0.75bmt standard steel studs @ 600mm spacing • 100mm glasswool insulation (14kg/m³) 	$R_w + C_{tr}$	48
			R_w	56
			STC	57
T1401-18		<ul style="list-style-type: none"> • 2 x 13mm fire-rated plasterboard each side (9.5kg/m² each layer) • Rondo 92 x 0.75bmt QUIET STUD® @ 600mm spacing • 100mm glasswool insulation (14kg/m³) 	$R_w + C_{tr}$	50
			R_w	58
			STC	58

TIMBER STUD WALLS

This section provides solutions for the Rondo Resilient Acoustic Mounts when used with the Rondo Furring Channel and multi-layer plasterboard linings, and mounted on timber stud walls.

Solutions are also provided for the Rondo Resilient Furring Channel when mounted on timber stud walls with plasterboard lining applied.

STWC:

Sound isolation mount, fixed directly to the wall framing, and directly supporting the Rondo Furring Channel. Provides acoustic separation between the wall linings and the supporting framework.



581:

Rondo Resilient Furring Channel, fixed directly to the wall framing. Provides acoustic separation between the wall linings and the supporting framework.



TIMBER STUD WALLS (continued)

In the following tables, the relevant NCC and NZBC complying rating values, are given for the nominated systems.

The complying values are shown in green.

We have also provided alternative systems,

determined by NDY which, in their opinion, are compliant with the NCC & NZBC minimum sound and impact insulation requirements.

Note: The Australian NCC ratings have a grey background and the NZBC pink.

1. TIMBER STUD WALL WITH ONE SIDE LINED ON FURRING CHANNEL WITH RONDO STWC ACOUSTIC MOUNTS

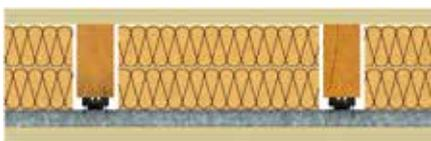
TEST ID	SYSTEM DIAGRAM	SYSTEM DESCRIPTION	SYSTEM RATING	
T1401-15		<ul style="list-style-type: none"> • 2 x 13mm fire-rated plasterboard each side (9.5kg/m² each layer) • 90mm timber studs @ 600mm centres, noggings @ 830mm centres • Rondo 28mm 129 Furring Channels @ 600mm vertical centres • STWC Furring Channel Clip @ 1200mm centres • 100mm glasswool partition batts (14kg/m³) 	$R_w + C_{tr}$	51
			R_w	60
			STC	61

2. TIMBER STUD WALL WITH ONE SIDE LINED ON RONDO 581 RESILIENT FURRING CHANNEL

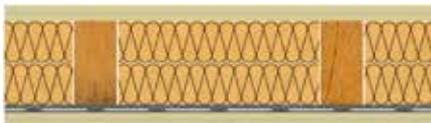
TEST ID	SYSTEM DIAGRAM	SYSTEM DESCRIPTION	SYSTEM RATING	
T1401-16		<ul style="list-style-type: none"> • 2 x 13mm fire-rated plasterboard each side (9.5kg/m² each layer) • 90mm timber studs @ 600mm centres, noggings @ 830mm centres • Rondo 581 Resilient Channel @ 600mm vertical centres • 100mm glasswool partition batts (14kg/m³) 	$R_w + C_{tr}$	49
			R_w	58
			STC	59

3. NDY OPINION TIMBER STUD WALL WITH ONE SIDE LINED ON RONDO 581 RESILIENT FURRING CHANNEL (Minimum NCC Compliance)

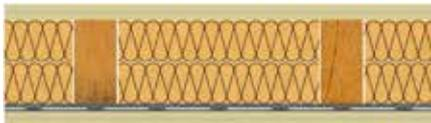
TEST ID	SYSTEM DIAGRAM	SYSTEM DESCRIPTION	SYSTEM RATING	
A-WTFir-R581-Opinion 2		<ul style="list-style-type: none"> • 1 x 13mm fire-rated plasterboard (10kg/m² each layer) + 1 x 16mm fire-rated plasterboard (12.3kg/m² each layer) • 90mm timber studs @ 600mm centres • Rondo 581 Resilient Channel @ 600mm vertical centres • 90mm fibreglass insulation (14kg/m³) 	$R_w + C_{tr}$	50
			R_w	59
			STC	60

4. NDY OPINION TIMBER STUD WALL WITH ONE SIDE LINED ON RONDO 581 RESILIENT FURRING CHANNEL

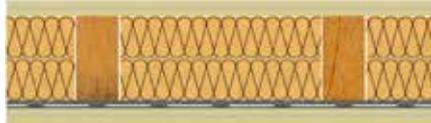
TEST ID	SYSTEM DIAGRAM	SYSTEM DESCRIPTION	SYSTEM RATING	
A-WTFir-R581-Opinion		<ul style="list-style-type: none"> • 2 x 16mm fire-rated plasterboard each side (12.3kg/m² each layer) • 90mm timber studs @ 600mm centres • Rondo 581 Resilient Channel @ 600mm vertical centres • 90mm fibreglass insulation (14kg/m³) 	$R_w + C_{tr}$	51
			R_w	60
			STC	61

MASONRY WALL SYSTEMS

This section provides solutions for the Rondo Resilient Acoustic Mounts when used with the Rondo Furring Channel and multi-layer plasterboard linings and mounted on masonry walls.

STWC:

Rondo sound isolation mount, fixed directly to the masonry, and directly supporting the Rondo Furring Channel. Provides acoustic separation between the wall linings and the supporting masonry.



BG03

Rondo BETAGRIP® BG03 sound isolation mount with anchor bolt for plumbing and levelling of Furring Channels when fixed directly to masonry walls. Provides acoustic separation between the wall linings and the supporting masonry.

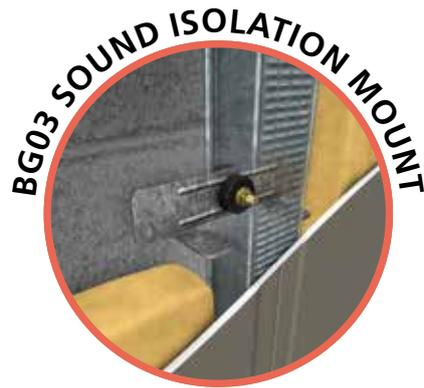

MASONRY WALL SYSTEMS (continued)

In the following tables, the relevant NCC and NZBC complying rating values are given for the nominated systems. **The complying values are shown in green.**

We have also provided alternative systems

determined by NDY which, in their opinion, are compliant with the NCC & NZBC minimum sound and impact insulation requirements.

Note: The Australian NCC ratings have a grey background and the NZBC pink.

1. MASONRY WALL WITH ONE SIDE LINED ON FURRING CHANNEL WITH RONDO STWC ACOUSTIC MOUNTS

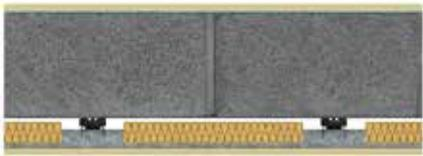
TEST ID	SYSTEM DIAGRAM	SYSTEM DESCRIPTION	SYSTEM RATING	
T1401-10		<ul style="list-style-type: none"> • 1 x 13mm fire-rated plasterboard daub fixed (9.5kg/m² each layer) • 190mm core-filled block (395kg/m²) • 50mm GW Partition Batts (11kg/m³) • STWC Furring Channel Clip @ 1200mm centres, 50mm cavity • Rondo 129 Furring Channels @ 600mm centres • 1 x 13mm fire-rated plasterboard (9.5kg/m² each layer) 	R _w + C _{tr}	54
			R _w	62
			STC	63

2. MASONRY WALL WITH BOTH SIDES LINED ON FURRING CHANNEL WITH RONDO STWC ACOUSTIC MOUNTS

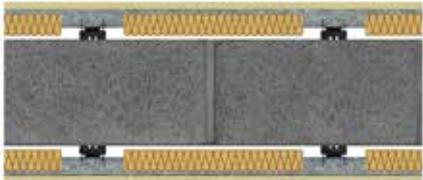
TEST ID	SYSTEM DIAGRAM	SYSTEM DESCRIPTION	SYSTEM RATING	
T1401-9		<ul style="list-style-type: none"> • 1 x 13mm fire-rated plasterboard each side (9.5 kg/m² each layer) • Rondo 129 Furring Channels @ 600mm centres each side • STWC Furring Channel Clip each side @ 1200mm centres, 50mm cavity • 50mm GW Partition Batts (11kg/m³) • 190mm core-filled block (395kg/m²) 	R _w + C _{tr}	55
			R _w	71
			STC	73

3. MASONRY WALL WITH ONE SIDE LINED ON FURRING CHANNEL WITH RONDO BETAGRIP® BG03 ACOUSTIC MOUNTS

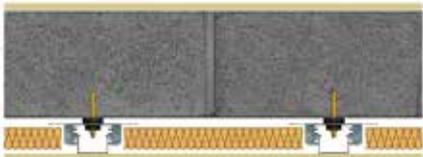
TEST ID	SYSTEM DIAGRAM	SYSTEM DESCRIPTION	SYSTEM RATING	
T1401-11		<ul style="list-style-type: none"> • 1 x 13mm fire-rated plasterboard daub fixed (9.5 kg/m² each layer) • 190mm core filled block (395kg/m²) • 50mm GW Partition Batts (11kg/m³) • BG03 Furring Channel Clip @ 1200mm centres, 50mm cavity • Rondo 129 Furring Channels @ 600mm centres • 1 x 13mm fire-rated plasterboard (9.5kg/m² each layer) 	R _w + C _{tr}	54
			R _w	63
			STC	64

RONDO STDC RESILIENT MOUNT

This product is designed to provide acoustical isolation of framing in situations where the framing is unable to clear span the area without additional 'structural' support.



As an example; the STDC mount enables a stud wall to be fixed back to an adjoining masonry or concrete wall, thus providing lateral support to the stud wall, yet still maintaining a degree of acoustical isolation.

The mount is secured to the web of the stud with two screw fixings and to the supporting wall with a suitable anchor cushioned through the attached resilient element. In this application the anchor should first be tightened to ensure it is 'set' properly and securely into the substrate.

The anchor nut should then be loosened off so that the rubber element of the mount is only compressed between 3 and 5mm at the absolute maximum to ensure the acoustic value of the mount is maximised

This form of construction is not 'discontinuous' and is not considered under the NCC and NZBC requirements, however it does have applications. Rondo cannot provide acoustic data on this type of construction due to the variabilities in construction form.

It should be noted that this form of construction is suited to applications requiring both a structural and acoustic solution, simultaneously.

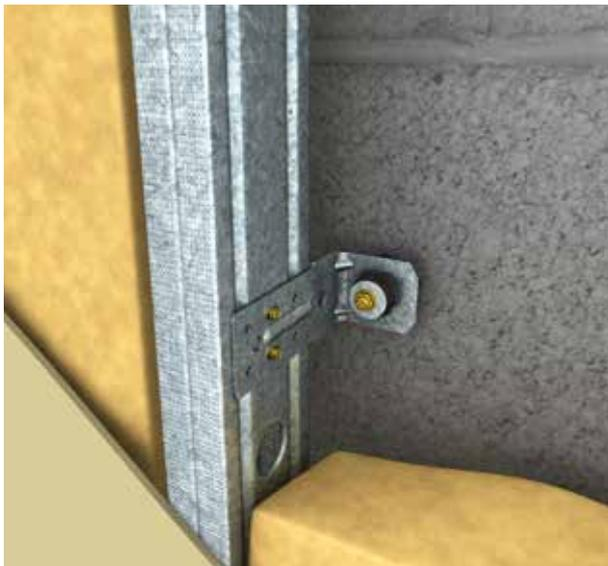

■ STDC MOUNT IN TYPICAL WALL INSTALLATION

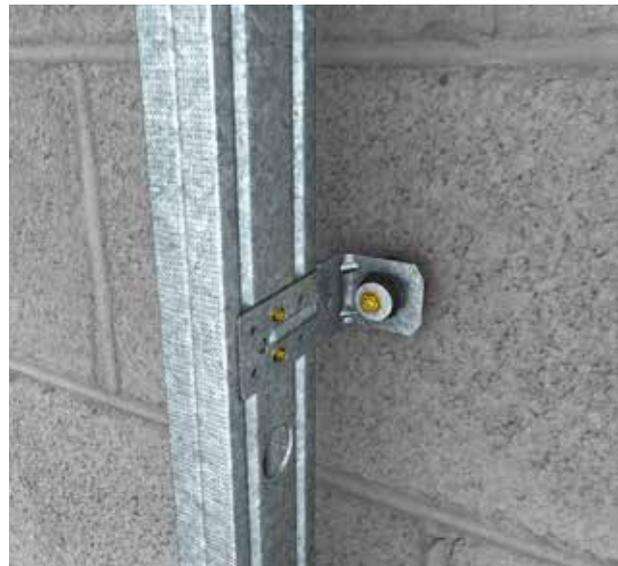

■ STDC MOUNTED ON MASONRY WALL AND SCREW FIXED TO WALL STUD

STANDARDS FOR MEASUREMENTS

AIRBORNE SOUND



Testing at CSIRO, Highett, Victoria:

- AS 1191-2002 - Acoustics – Methods for laboratory measurement of airborne sound insulation of building elements.
- AS/NZS 1276.1 : 1999 (ISO 717-1 : 1996) - Acoustics – Rating of sound insulation in buildings and of building elements. Part 1 : Airborne Sound Insulation
- ASTM E 413-87 (Reapproved 1999) - Classification for Rating Sound Insulation

Testing at Auckland University, New Zealand:

- ISO 10140-2 : 2010 (E) - Laboratory measurement of sound insulation of building elements. Part 2 – Measurement of airborne sound insulation
- AS/NZS 1276.1 : 1999 (ISO 717-1 : 1996) - Acoustics – Rating of sound insulation in buildings and of building elements. Part 1 : Airborne Sound Insulation
- ASTM E 413-87 (Reapproved 1999) - Classification for Rating Sound Insulation

IMPACT SOUND



Testing at CSIRO, Highett, Victoria:

- AS ISO 140.6 – 2006 - Laboratory measurement of impact sound insulation of floors.
- AS ISO 717.2 – 2004 - Acoustics – Rating of sound insulation in buildings and of building elements. Part 2 Impact sound insulation
- ASTM E 989-89 (Reapproved 1999) - Standard Classification for Determination of Impact Insulation Class (IIC)

Testing at Auckland University, New Zealand:

- ISO 10140 – 3 : 2010 Laboratory measurement of impact sound insulation of building elements. Part 3 : Measurement of impact sound insulation.
- AS ISO 717.2 – 2004 - Acoustics – Rating of sound insulation in buildings and of building elements. Part 2 Impact sound insulation
- ASTM E 989-89 (Reapproved 1999) - Standard Classification for Determination of Impact Insulation Class (IIC)

ACKNOWLEDGEMENTS

NORMAN DISNEY & YOUNG

Rondo Building Services acknowledges the significant contribution made by its consultants, NDY Acoustics, in the rigorous testing program and subsequent preparation of this manual.

NDY's expert professional services have contributed immensely to the production of this manual, and included the assessment of our acoustic range and technical data, advice and assistance in preparation of a testing programme, analysis of the results, and provision where appropriate of specific system opinions.

PLASTERBOARD & INSULATION MANUFACTURERS

Rondo Building Services recognises that individual suppliers and manufacturers of plasterboard and insulation products should be consulted for brand specific acoustical specifications.

RONDO OFFICES

AUSTRALIA: RONDO BUILDING SERVICES PTY LTD
CUSTOMER SERVICE HOTLINE: 1300-36-RONDO (1300-36-7663)

NEW SOUTH WALES
57-87 Lockwood Road Erskine Park NSW 2759
(PO Box 324 St Marys NSW 1790)
phone: 61-2-9912 7300 fax: 61-2-9912 7310 email: nsw@rondo.com.au

VICTORIA
12-14 Dunlop Road Mulgrave VIC 3170
(Private Bag 23 Mulgrave VIC 3170)
phone: 61-3-8561 2222 fax: 61-3-8561 2266 email: vic@rondo.com.au

QUEENSLAND
13 Binary Street Yatala QLD 4207
(PO Box 6006 Yatala QLD 4207)
phone: 61-7-3442 6400 fax: 61-7-3442 6427 email: qld@rondo.com.au

SOUTH AUSTRALIA
39 George Street Green Fields SA 5107
phone: 61-8-8256 5900 fax: 61-8-8256 5922 email: sa@rondo.com.au

WESTERN AUSTRALIA
5 Hazelhurst Street Kewdale WA 6105
(PO Box 168 Cloverdale WA 6985)
phone: 61-8-9251 9400 fax: 61-8-9251 9414 email: wa@rondo.com.au

HEAD OFFICE
57-87 Lockwood Road Erskine Park NSW 2759
(PO Box 324 St Marys NSW 1790)
phone: 61-2-9912 7300 fax: 61-2-9912 7310 email: rondo@rondo.com.au

EXPORT phone: 61-438-427-479 fax: 61-7-3287-1881 email: export@rondo.com.au

NEW ZEALAND: RONDO BUILDING SERVICES PTY LTD
FREE CALL: 0800-0800-RONDO (0800-0800-76)
www.rondo.co.nz

AUCKLAND
117 Captain Springs Road Onehunga
Auckland 1061
(PO Box 12464 Penrose Auckland 1642)
phone: 64-9-636 5110 fax: 64-9-636 5111 email: rondo.newzealand@rondo.co.nz

CHRISTCHURCH
106 F Carmen Road Hornby Christchurch 8042
phone: 64-3-421 7840 fax: 64-9-636 5111

MALAYSIA: RONDO METAL PRODUCTS SDN BHD
Lot 606, off Jalan SS13/1K
47500 Subang Jaya Selangor
phone: 60-3-5636 0710 fax: 60-3-5636 0711 email: rondo.malaysia@rondo.com.my
www.rondo.asia

UAE: RONDO METAL PRODUCTS SDN BHD
Al Saraya Avenue Building Al Garhoud Dubai UAE
(PO Box 14424 Dubai UAE)
phone: 971-505-511-893

INDIA: RONDO METAL SYSTEMS PVT LTD
Plot J-21, MIDC Talaja, Tal, Panvel
Dist Raigad - 410 208 Mumbai India
phone: 91-22-2740 2831 email: rondo.india@rondo.co.in
www.rondo.co.in

RONDO®

www.rondo.com.au

RONDO®